



HR 500

HR 500

Solid carbide high-performance reamers up to Ø 20 mm for universal application

HR 500 Guss

Solid carbide high-performance reamers for the machining of GG and GGG achieving optimal surface quality and efficiency

HR 500 Alu

Solid carbide high-performance reamers for the machining of aluminum and AlSi-alloys

HR 500 G

Carbide- or cermet-tipped high-performance reamers from Ø 20 mm up to 40 mm

HR 500 GT

Carbide- or cermet-tipped high-performance reamers from Ø 40 mm up to 76.2 mm

HR 500 ACTIVE

Special range of solid carbide high-performance reamers

Edition 2014

EXCLUSIVELINE®

Made by Guhring

EXCLUSIVE^{LINE}[®]

HR 500 high-performance reamers Pictograms

Tool material	VHM Solid carbide	HM Carbide-tipped	Cermet
Internal cooling			
Standard	 to Guhring standard		
Type	HR 500 S Blind hole (S)	HR 500 Guss S HR 500 Alu S HR 500 G S HR 500 GT S	HR 500 D Through hole (D)
Cutting direction	 r-h		
Tolerance	H7	+0,005	
Hole type	 Through hole	 Blind hole	
No. of cutting edges			
Shank form			
Helix angle	 straight-fluted		
Spacing	 extremely unequal		

Our price list no. 42 replaces all previous price lists. All prices in Euro plus surcharge and VAT. Re-production – even in part – is not permitted.

Possible misprints or any type of intermediate changes do not entitle to any claims. All DIN marked products can be supplied deviating from the catalog dimensions as long as they correspond to the specified DIN standard.

EXCLUSIVE LINE®

HR 500 high-performance reamers



HR 500 HIGH-PERFORMANCE REAMERS

Perfect reaming in all diameters

HR 500 high-performance reamers are the optimal tooling solution for all diameters from 2.97 to 76.2 mm.

To apply the optimally designed HR 500 high-performance reamer a range of various HR 500 options is available.

- Solid carbide reamers up to diameter 20.00 mm
- Carbide and cermet-tipped reamers up to diameter 40.00 mm
- Carbide and cermet-tipped head reamers up to diameter 76.2 mm
- Solid carbide reamers for intermediate dimensions and stepped tools in HR 500 Active program

EXCLUSIVELINE®

HR 500 high-performance reamers Program summary

Standard	Type	Tool illustration	Tool material	Surface finish	d1	Guhring no.	Standard range page	
	HR 500 S		Solid carbide		3.000 - 20.000	1685	7	
	HR 500 S		Solid carbide		2.970 - 12.030	1675	8	
	HR 500 D		Solid carbide		3.000 - 20.000	1686	7	
	HR 500 D		Solid carbide		2.970 - 12.030	1676	8	
	HR 500 Guss S		Solid carbide		3.000 - 20.000	1036	10	
	HR 500 Guss D		Solid carbide		3.000 - 20.000	1037	10	
	HR 500 Alu S		Solid carbide		4.000 - 20.000	1678	11	
	HR 500 Alu D		Solid carbide		4.000 - 20.000	1679	11	
	HR 500 G S		Carbide		22.000 - 40.000	1680	12	
	HR 500 G S		Cermet tipped		22.000 - 40.000	1682	13	
	HR 500 G D		Carbide		22.000 - 40.000	1681	12	
	HR 500 G D		Cermet tipped		22.000 - 40.000	1683	13	
	HR 500 GT S		Semi-standard	Carbide		41.000 - 76.000	1038	15
	HR 500 GT S		Semi-standard	Cermet tipped		41.000 - 76.000	1040	16
	HR 500 GT D		Semi-standard	Carbide		41.000 - 76.000	1039	15

bright









TiAlN nanoA

Carbo

Signum

EXCLUSIVE^{LINE}[®]

HR 500 high-performance reamers Program summary

Standard	Type	Tool illustration	Tool material	Surface finish	d1	Guhring no	Standard range page
	HR 500 GT D	 Semi-standard	Cermet tipped		41.000 - 76.000	1041	16
HSK-A hydraulic chucks, extra length, for HR 500 GT							
					HSK-A 63	4290	17
Hydraulic chucks							
HSK					HSK-A 63 - HSK-A 100	4299	18
HSK					CAT 40 +CAT 50	4216	19
Adaptors							
					CAT 40 HSK-C 63 CAT 50 HSK-C 63	4003	20

Tool selection for optimal economy and quality

			Ø ≤ 20 mm			Ø > 20 mm		
			Solid carbide HR 500	Solid carbide HR500 Guss	Solid carbide HR500 Alu	Carbide tipped HR500	Cermet tipped HR500	
			1675	1676	1036	1678	1680/1038	1682/1040
			1685	1686	1037	1679	1681/1039	1683/1041
Steel	P	up to 1200 N/mm ²	●	●			○	●
Stainless steel	M		●	●			●	
Cast iron	K	GG	○	○	●		●	
		GGG 40/50	○	○	●		○	●
		GGG 60/70	○	○	●		●	
Aluminum	N				●			
Ti-special alloys	S	Ti-Basis	●	●			●	
		Ni-Basis	●	●			●	
Hardened steel	H	up to 48 HRC	●	●			○	
		up to 63 HRC	●	●				

● optimal suitability ○ limited suitability

Optimal diameters of pre-drilled holes

Recommended stock allowance, in mm			up to Ø6	up to Ø10	up to Ø16	up to Ø25	up to Ø40	above Ø40
all materials			Ø 0.1 - 0.2	Ø 0.2	Ø 0.2 - 0.3	Ø 0.3	Ø 0.3 - 0.4	Ø 0.4 - 0.5
Hardened steel	H	up to 48 HRC	Ø 0.1 - 0.2	Ø 0.2	Ø 0.2	Ø 0.2	Ø 0.3	Ø 0.3
		up to 63 HRC	Ø 0.1	Ø 0.1	Ø 0.1 - 0.2	Ø 0.2	Ø 0.2	Ø 0.2

EXCLUSIVE LINE®

Special solution HR 500 T

HR 500 T

With the HR 500 T Guhring now provides solid carbide head reamers from 20 to 36 mm diameter as a special solution.

This special solution expands the successful solid carbide HR 500 version up to 36 mm diameter. Thanks to the short, compact solution the raw material costs remain limited. However, it is possible to take advantage of the universal options of the HR 500 in monoblock design.

Thanks to the universal HA shank the HR 500 T can be flexibly combined with standard chucks and numerous extensions. This considerable advantage makes expensive special holders unnecessary. The reaming operation can be carried out cost-efficiently and of high quality.

Your advantages at a glance:

- flexible holder options thanks to HA shank
- simple extension with shrink fit extension or hydraulic chuck
- design includes universal, cast iron or aluminum options



Shrink fit extension (Guhring no. 4719)

EXCLUSIVELINE®

HR 500 solid carbide high-performance reamers



High-performance reamers



The solid carbide HPC reamer HR 500 operates with highest cutting rates and produces extremely high-quality holes. Therefore, it often enables considerable savings in the process costs. In addition, it provides very high process reliability.

The special coolant supply of the type HS 500 D with flutes in the shank ensures optimal chip evacuation and reliable cooling.

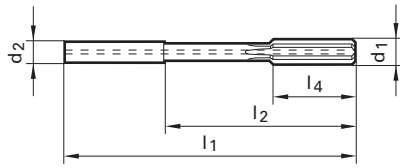

		Solid carbide	
		HR 500 S	HR 500 D
Guhring no.		1685	1686
Surface finish			
Discount group		166	166



Code no.	d1	d2 h6	l1	l2	l4	
	mm	mm	mm	mm	mm	
3.000	3.000	4.000	68.00	40.00	12.00	4
3.500	3.500	4.000	68.00	40.00	12.00	4
4.000	4.000	4.000	68.00	40.00	12.00	4
4.500	4.500	6.000	76.00	40.00	12.00	4
5.000	5.000	6.000	76.00	40.00	12.00	4
5.500	5.500	6.000	76.00	40.00	12.00	4
6.000	6.000	6.000	76.00	40.00	12.00	4
6.500	6.500	8.000	101.00	65.00	16.00	6
7.000	7.000	8.000	101.00	65.00	16.00	6
7.500	7.500	8.000	101.00	65.00	16.00	6
8.000	8.000	8.000	101.00	65.00	16.00	6
8.500	8.500	10.000	101.00	61.00	19.00	6
9.000	9.000	10.000	101.00	61.00	19.00	6
9.500	9.500	10.000	101.00	61.00	19.00	6
10.000	10.000	10.000	101.00	61.00	19.00	6
10.500	10.500	12.000	130.00	85.00	19.00	6
11.000	11.000	12.000	130.00	85.00	19.00	6
11.500	11.500	12.000	130.00	85.00	19.00	6
12.000	12.000	12.000	130.00	85.00	19.00	6
13.000	13.000	14.000	130.00	85.00	22.00	6
14.000	14.000	14.000	130.00	85.00	22.00	6
15.000	15.000	16.000	150.00	102.00	22.00	6
16.000	16.000	16.000	150.00	102.00	22.00	6
17.000	17.000	18.000	150.00	102.00	25.00	6
18.000	18.000	18.000	150.00	102.00	25.00	6
19.000	19.000	20.000	150.00	100.00	25.00	6
20.000	20.000	20.000	150.00	100.00	25.00	6

Availability	
●	●
●	●
●	●
●	●
●	●
●	●
●	●
●	●
●	●
●	●
●	●
●	●
●	●
●	●
●	●
●	●
●	●
●	●
●	●
●	●
●	●

EXCLUSIVE LINE®

HR 500 solid carbide high-performance reamers



High-performance reamers



The solid carbide HPC reamer HR 500 operates with highest cutting rates and produces extremely high-quality holes. Therefore, it often enables considerable savings in the process costs. In addition, it provides very high process reliability.

The special coolant supply of the type HS 500 D with flutes in the shank ensures optimal chip evacuation and reliable cooling.

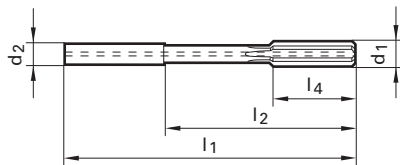

Code no.	d1	d2 h6	l1	l2	l4	
	mm	mm				
2.970	2.970	4.000	68.00	40.00	12.00	4
2.980	2.980	4.000	68.00	40.00	12.00	4
2.990	2.990	4.000	68.00	40.00	12.00	4
3.000	3.000	4.000	68.00	40.00	12.00	4
3.010	3.010	4.000	68.00	40.00	12.00	4
3.020	3.020	4.000	68.00	40.00	12.00	4
3.030	3.030	4.000	68.00	40.00	12.00	4
3.970	3.970	4.000	68.00	40.00	12.00	4
3.980	3.980	4.000	68.00	40.00	12.00	4
3.990	3.990	4.000	68.00	40.00	12.00	4
4.000	4.000	4.000	68.00	40.00	12.00	4
4.010	4.010	4.000	68.00	40.00	12.00	4
4.020	4.020	4.000	68.00	40.00	12.00	4
4.030	4.030	4.000	68.00	40.00	12.00	4
4.970	4.970	6.000	76.00	40.00	12.00	4
4.980	4.980	6.000	76.00	40.00	12.00	4
4.990	4.990	6.000	76.00	40.00	12.00	4
5.000	5.000	6.000	76.00	40.00	12.00	4
5.010	5.010	6.000	76.00	40.00	12.00	4
5.020	5.020	6.000	76.00	40.00	12.00	4
5.030	5.030	6.000	76.00	40.00	12.00	4
5.970	5.970	6.000	76.00	40.00	12.00	4
5.980	5.980	6.000	76.00	40.00	12.00	4
5.990	5.990	6.000	76.00	40.00	12.00	4
6.000	6.000	6.000	76.00	40.00	12.00	4
6.010	6.010	6.000	76.00	40.00	12.00	4
6.020	6.020	6.000	76.00	40.00	12.00	4
6.030	6.030	6.000	76.00	40.00	12.00	4
7.000	7.000	8.000	101.00	65.00	16.00	6
7.970	7.970	8.000	101.00	65.00	16.00	6

Solid carbide



Guhring no.

1675

1676

Surface finish

a

a

Discount group

166

166



Availability

●	●
●	●
●	●
●	●
●	●
●	●
●	●
●	●
●	●
●	●
●	●
●	●
●	●
●	●
●	●
●	●
●	●
●	●
●	●
●	●
●	●
●	●
●	●
●	●
●	●
●	●
●	●
●	●

EXCLUSIVELINE®

HR 500 solid carbide high-performance reamers

Universal

High-performance reamers



The solid carbide HPC reamer HR 500 operates with highest cutting rates and produces extremely high-quality holes. Therefore, it often enables considerable savings in the process costs. In addition, it provides very high process reliability.

The special coolant supply of the type HS 500 D with flutes in the shank ensures optimal chip evacuation and reliable cooling.

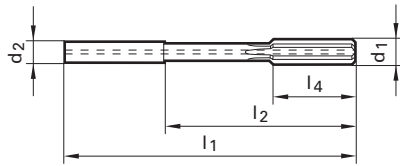

Code no.	d1	d2 h6	l1	l2	l4	
	mm	mm	mm	mm	mm	
7.980	7.980	8.000	101.00	65.00	16.00	6
7.990	7.990	8.000	101.00	65.00	16.00	6
8.000	8.000	8.000	101.00	65.00	16.00	6
8.010	8.010	8.000	101.00	65.00	16.00	6
8.020	8.020	8.000	101.00	65.00	16.00	6
8.030	8.030	8.000	101.00	65.00	16.00	6
9.000	9.000	10.000	101.00	61.00	19.00	6
9.970	9.970	10.000	101.00	61.00	19.00	6
9.980	9.980	10.000	101.00	61.00	19.00	6
9.990	9.990	10.000	101.00	61.00	19.00	6
10.000	10.000	10.000	101.00	61.00	19.00	6
10.010	10.010	10.000	101.00	61.00	19.00	6
10.020	10.020	10.000	101.00	61.00	19.00	6
10.030	10.030	10.000	101.00	61.00	19.00	6
11.000	11.000	12.000	130.00	85.00	19.00	6
11.970	11.970	12.000	130.00	85.00	19.00	6
11.980	11.980	12.000	130.00	85.00	19.00	6
11.990	11.990	12.000	130.00	85.00	19.00	6
12.000	12.000	12.000	130.00	85.00	19.00	6
12.010	12.010	12.000	130.00	85.00	19.00	6
12.020	12.020	12.000	130.00	85.00	19.00	6
12.030	12.030	12.000	130.00	85.00	19.00	6

Solid carbide



Guhring no.

1675

1676

Surface finish

a

a

Discount group

166

166



Availability



○ bright

a TIAIN nanoA

Cb Carbo

Y Signum

EXCLUSIVE LINE®

HR 500 Cast solid carbide high-performance reamers



High-performance reamers Cast



The solid carbide HPC reamer HR 500 operates with highest cutting rates and produces extremely high-quality holes. Therefore, it often enables considerable savings in the process costs. In addition, it provides very high process reliability.

The special coolant supply of the type HS 500 D with flutes in the shank ensures optimal chip evacuation and reliable cooling.

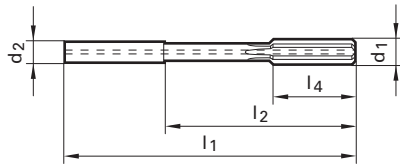

Code no.	d1	d2 h6	l1	l2	l4	
	mm	mm				
3.000	3.000	4.000	68.00	40.00	12.00	6
4.000	4.000	4.000	68.00	40.00	12.00	6
5.000	5.000	6.000	76.00	40.00	12.00	6
6.000	6.000	6.000	76.00	40.00	12.00	6
7.000	7.000	8.000	101.00	65.00	16.00	8
8.000	8.000	8.000	101.00	65.00	16.00	8
9.000	9.000	10.000	101.00	61.00	19.00	8
10.000	10.000	10.000	101.00	61.00	19.00	8
11.000	11.000	12.000	130.00	85.00	19.00	8
12.000	12.000	12.000	130.00	85.00	19.00	8
13.000	13.000	14.000	130.00	85.00	22.00	8
14.000	14.000	14.000	130.00	85.00	22.00	8
15.000	15.000	16.000	150.00	102.00	22.00	8
16.000	16.000	16.000	150.00	102.00	22.00	8
17.000	17.000	18.000	150.00	102.00	25.00	8
18.000	18.000	18.000	150.00	102.00	25.00	8
19.000	19.000	20.000	150.00	100.00	25.00	8
20.000	20.000	20.000	150.00	100.00	25.00	8

Solid carbide



Guhring no.	1036	1037
Surface finish		
Discount group	166	166
	H7	H7



Availability

●	●
●	●
●	●
●	●
●	●
●	●
●	●
●	●
●	●
●	●
●	●
●	●
●	●
●	●
●	●
●	●
●	●
●	●
●	●
●	●

EXCLUSIVE LINE®

HR 500 ALU solid carbide high-performance reamers



High-performance reamers ALU



The solid carbide HPC reamer HR 500 operates with highest cutting rates and produces extremely high-quality holes. Therefore, it often enables considerable savings in the process costs. In addition, it provides very high process reliability.

The special coolant supply of the type HS 500 D with flutes in the shank ensures optimal chip evacuation and reliable cooling.

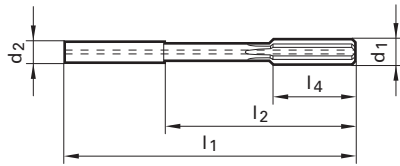

Code no.	d1	d2 h6	l1	l2	l4	
	mm	mm	mm	mm	mm	
4.000	4.000	4.000	68.00	40.00	12.00	4
5.000	5.000	6.000	76.00	40.00	12.00	4
6.000	6.000	6.000	76.00	40.00	12.00	4
7.000	7.000	8.000	101.00	65.00	16.00	6
8.000	8.000	8.000	101.00	65.00	16.00	6
10.000	10.000	10.000	101.00	61.00	19.00	6
12.000	12.000	12.000	130.00	85.00	19.00	6
14.000	14.000	14.000	130.00	85.00	22.00	6
16.000	16.000	16.000	150.00	102.00	22.00	6
18.000	18.000	18.000	150.00	102.00	25.00	6
20.000	20.000	20.000	150.00	100.00	25.00	6

Solid carbide

HR 500
Alu S



HR 500
Alu D



Guhring no.

1678

1679

Surface finish

ⓐ

ⓐ

Discount group

166

166



H7



H7



Availability



EXCLUSIVE LINE®

HR 500 G high-performance reamers

High-performance reamers



The carbide- or cermet-tipped HR 500 G produces first-class hole qualities with highest cutting rates. In addition, it provides a very high process reliability and considerably reduces process costs.

Further advantages:

- Intermediate dimensions from Ø 20.1 mm can be supplied at short notice
- Carbide-tipped tools with “Signum”-coating for GG machining meeting highest demands on surface quality of hole (cutting rates see Guhring no. 1036/1037)
- Carbide-tipped tools with “Carbo”-coating for the machining of aluminum (cutting rates see Guhring no. 1678/1679)

Intermediate sizes short delivery

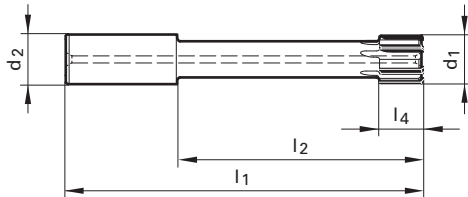

Code no.	d1	d2 h6	l1	l2	l4	
	mm	mm	mm	mm	mm	
22.000	22.000	20.000	160.00	110.00	22.00	6
24.000	24.000	25.000	180.00	124.00	22.00	6
25.000	25.000	25.000	180.00	124.00	22.00	6
26.000	26.000	25.000	180.00	124.00	22.00	6
28.000	28.000	25.000	180.00	124.00	25.00	6
30.000	30.000	25.000	180.00	124.00	25.00	6
32.000	32.000	32.000	200.00	140.00	25.00	6
34.000	34.000	32.000	200.00	140.00	25.00	6
36.000	36.000	32.000	200.00	140.00	25.00	8
38.000	38.000	32.000	200.00	140.00	25.00	8
40.000	40.000	32.000	200.00	140.00	25.00	8

Carbide



Guhring no.	1680	1681
Surface finish		
Discount group	166	166



Availability	
●	●
●	●
●	●
●	●
●	●
●	●
●	●
●	●
●	●
●	●

When ordering intermediate hole sizes, fill out the questionnaire on page 31.

EXCLUSIVE LINE®

HR 500 G high-performance reamers

High-performance reamers



The carbide- or cermet-tipped HR 500 G produces first-class hole qualities with highest cutting rates. In addition, it provides a very high process reliability and considerably reduces process costs.

Intermediate sizes short delivery

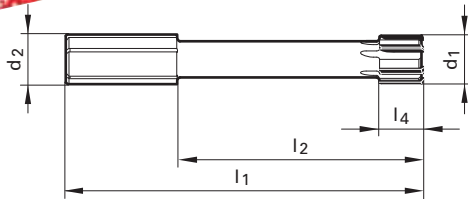

Code no.	d1	d2 h6	l1	l2	l4	
	mm	mm	mm	mm	mm	
22.000	22.000	20.000	160.00	110.00	22.00	6
24.000	24.000	25.000	180.00	124.00	22.00	6
25.000	25.000	25.000	180.00	124.00	22.00	6
26.000	26.000	25.000	180.00	124.00	22.00	6
28.000	28.000	25.000	180.00	124.00	25.00	6
30.000	30.000	25.000	180.00	124.00	25.00	6
32.000	32.000	32.000	200.00	140.00	25.00	6
34.000	34.000	32.000	200.00	140.00	25.00	6
36.000	36.000	32.000	200.00	140.00	25.00	8
38.000	38.000	32.000	200.00	140.00	25.00	8
40.000	40.000	32.000	200.00	140.00	25.00	8

Cermet-tipped



Guhring no.

1682

1683

Surface finish



Discount group

166

166



Availability



When ordering intermediate hole sizes, fill out the questionnaire on page 31.

EXCLUSIVE LINE[®]

HR 500 GT high-performance reamers

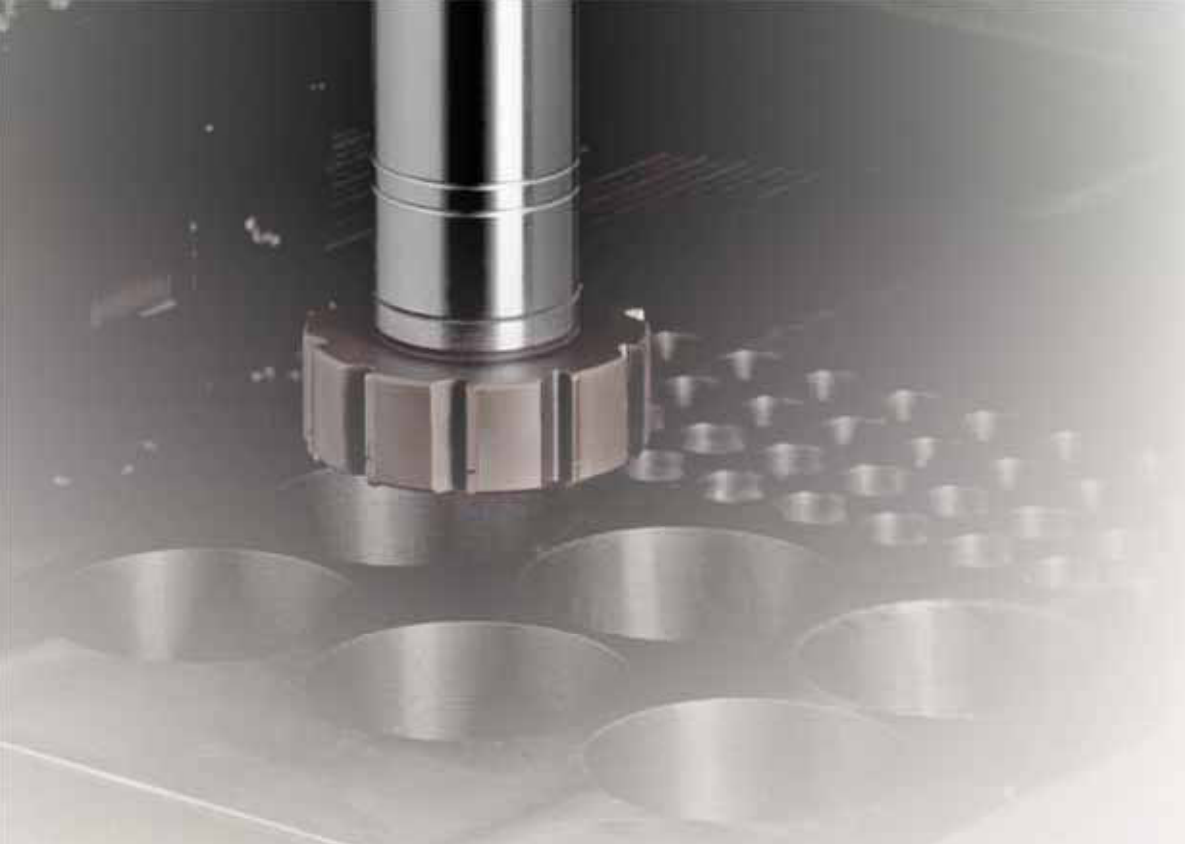

HR 500 GT high-performance reamers top performance above Ø 40.00 mm

Also for diameters above 40.00 mm Guhring's HR 500 technology is first choice for high-performance reaming. Numerous intelligent solutions ensure also with large diameters maximum cutting rates and optimal quality:

Variety for perfect machining results

The HR 500 GT tool heads are available in the semi-standard range with short delivery times in the diameter range > 40.0 to 76.2 mm for the following material specific ranges:

- Carbide-tipped with nanoA-coating for stainless steels, GGG 60, GG, special alloys and non-ferrous metals
- Carbide-tipped with Signum-coating with high demands on surface quality for GG and GGG 60
- Carbide-tipped with Carbo-coating for Al machining
- Cermet-tipped for steels and GGG 40/50

In addition, we manufacture special tools to customer specific requirements on request.

Optimal cooling lubrication

Thanks to the newly developed, patent applied for, re-direction screw at the face side of the HR 500 GT tool heads, the cooling lubricant process reliably reaches the cutting edges. It is impossible for chips to clog up the cooling lubricant exits. Thanks to the especially flat design of the re-direction screw the machining of blind holes is possible right up to the base of the hole.

If necessary, the re-direction screw can be removed for the machining of blind holes.



EXCLUSIVE LINE®

HR 500 GT high-performance reamers

High-performance reamers



HR 500 GT as semi-standard
Straight shank ~ DIN 6535 HA tol. H6 with tang for optimal holding in extra length, slender hydraulic chuck Guhring no. 4290, but also in conventional hydraulic chucks or shrink fit chucks.
Further advantages:

- Intermediate dimensions from Ø 40.0-76.2 mm can be supplied at short notice
 - Carbide-tipped tools with "Signum"-coating for GG machining meeting highest demands on surface quality of hole (cutting rates see Guhring no. 1036/1037)
 - Carbide-tipped tools with "Carbo"-coating for the machining of aluminum (cutting rates see Guhring no. 1678/1679)
- Minimum order quantity is 2.

When applying long hydraulic chucks with tang:
Eliminate play between chuck and reamer by rotating to stop prior to clamping.

Intermediate sizes short delivery

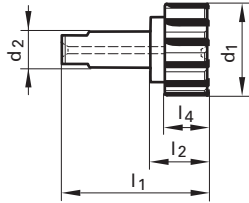

Code no.	d1	d2 h6	l1	l2	l4	8
	mm	mm				
41.000	41.000	25.000	90.00	34.00	25.00	8
42.000	42.000	25.000	90.00	34.00	25.00	8
44.000	44.000	25.000	90.00	34.00	25.00	8
46.000	46.000	25.000	90.00	34.00	25.00	8
47.000	47.000	25.000	90.00	34.00	25.00	8
48.000	48.000	25.000	90.00	34.00	25.00	8
50.000	50.000	25.000	90.00	34.00	25.00	8
52.000	52.000	25.000	90.00	34.00	25.00	8
53.000	53.000	25.000	90.00	34.00	25.00	8
54.000	54.000	25.000	90.00	34.00	25.00	8
56.000	56.000	25.000	90.00	34.00	25.00	8
58.000	58.000	25.000	90.00	34.00	25.00	8
59.000	59.000	32.000	95.00	35.00	25.00	8
60.000	60.000	32.000	95.00	35.00	25.00	8
62.000	62.000	32.000	95.00	35.00	25.00	8
64.000	64.000	32.000	95.00	35.00	25.00	8
65.000	65.000	32.000	95.00	35.00	25.00	8
66.000	66.000	32.000	95.00	35.00	25.00	10
68.000	68.000	32.000	95.00	35.00	25.00	10
70.000	70.000	32.000	95.00	35.00	25.00	10
71.000	71.000	32.000	95.00	35.00	25.00	10
72.000	72.000	32.000	95.00	35.00	25.00	10
74.000	74.000	32.000	95.00	35.00	25.00	10
76.000	76.000	32.000	95.00	35.00	25.00	10

Carbide



Guhring no.

1038

1039

Surface finish

a

a

Discount group

166

166



Availability



When ordering intermediate hole sizes, fill out the questionnaire on page 31.

EXCLUSIVELINE[®]

HR 500 GT high-performance reamers

High-performance reamers



HR 500 GT as semi-standard

Straight shank ~ DIN 6535 HA tol. H6 with tang for optimal holding in extra length, slender hydraulic chuck Guhring no. 4290, but also in conventional hydraulic chucks or shrink fit chucks.

Minimum order quantity is 2.

When applying long hydraulic chucks with tang:
Eliminate play between chuck and reamer by rotating to stop prior to clamping.

**Intermediate sizes
short delivery**

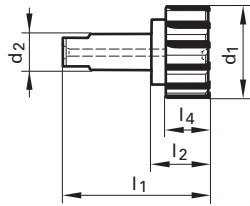

Code no.	d1	d2 h6	l1	l2	l4	
	mm	mm				
41.000	41.000	25.000	90.00	34.00	25.00	8
42.000	42.000	25.000	90.00	34.00	25.00	8
44.000	44.000	25.000	90.00	34.00	25.00	8
46.000	46.000	25.000	90.00	34.00	25.00	8
47.000	47.000	25.000	90.00	34.00	25.00	8
48.000	48.000	25.000	90.00	34.00	25.00	8
50.000	50.000	25.000	90.00	34.00	25.00	8
52.000	52.000	25.000	90.00	34.00	25.00	8
53.000	53.000	25.000	90.00	34.00	25.00	8
54.000	54.000	25.000	90.00	34.00	25.00	8
56.000	56.000	25.000	90.00	34.00	25.00	8
58.000	58.000	25.000	90.00	34.00	25.00	8
59.000	59.000	32.000	95.00	35.00	25.00	8
60.000	60.000	32.000	95.00	35.00	25.00	8
62.000	62.000	32.000	95.00	35.00	25.00	8
64.000	64.000	32.000	95.00	35.00	25.00	8
65.000	65.000	32.000	95.00	35.00	25.00	8
66.000	66.000	32.000	95.00	35.00	25.00	10
68.000	68.000	32.000	95.00	35.00	25.00	10
70.000	70.000	32.000	95.00	35.00	25.00	10
71.000	71.000	32.000	95.00	35.00	25.00	10
72.000	72.000	32.000	95.00	35.00	25.00	10
74.000	74.000	32.000	95.00	35.00	25.00	10
76.000	76.000	32.000	95.00	35.00	25.00	10

Cermet-tipped



Guhring no.

1040

1041

Surface finish



Discount group

166

166



Availability

●	●
●	●
●	●
●	●
●	●
●	●
●	●
●	●
●	●
●	●
●	●
●	●
●	●
●	●
●	●
●	●
●	●
●	●
●	●
●	●
●	●
●	●

When ordering intermediate hole sizes, fill out the questionnaire on page 31.

EXCLUSIVE LINE®

HSK-A hydraulic chucks, extra length, for HR 500 GT

HSK-A hydraulic chucks, extra length



For high precision reamers HR 500 GT with tang.

Scope of delivery:

- incl. adjustment screw Guhring no. 4900
- incl. hexagon chuck key Guhring no. 4912
- order coolant delivery set Guhring no. 4949 separately

Guhring no.	4290
Surface finish	
Discount group	114

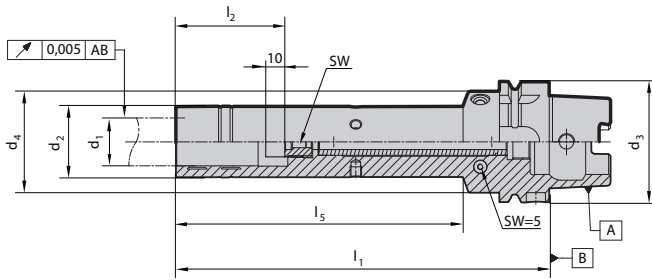

Code no.	d3	f. d1 h6	d2	d4	l1	l2	l5	incl.	SW	kg
25.063	63	25	37	53	195	57	150	20.114	5.0	1.9
25.163	63	25	37	53	295	57	250	20.114	5.0	2.7
32.063	63	32	44	53	195	61	150	20.114	5.0	2.2
32.163	63	32	44	53	295	61	250	20.114	5.0	3.4

Availability
●
●
●

When ordering intermediate hole sizes, fill out the questionnaire on page 31.

EXCLUSIVE LINE®

HSK-A hydraulic chucks with increased clamping force

Product information

- balancing quality: G6.3 / 15,000 rev./min
- axial length setting
- max. deviation f. concentricity 3 µm
- for tool shank tolerance h6
- to DIN 69882-7
- also available in extra-long lengths
l1 = 150 / 160 mm and 200 mm
- HSK-A to DIN 69893

Scope of delivery

- incl. adjustment screw Guhring no. 4900
- incl. hexagon chuck key Guhring no. 4912
- order coolant delivery set Guhring no. 4949 separately

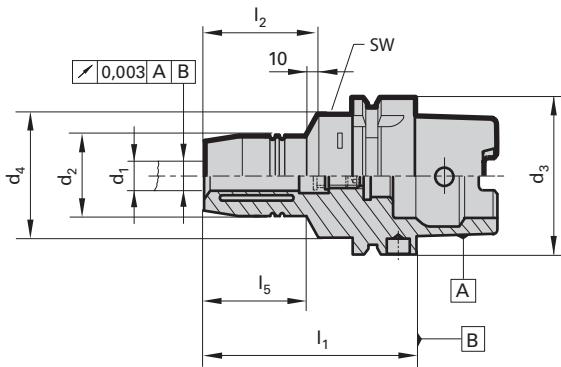

Series Number **4299**

HSK-A d3	for shank Ø d1 h6 mm	d2 mm	d4 mm	l1 mm	l2 mm	l5 mm	incl. setting screw 4900 ...	SW	kg	Code no.	EDP
63	20	42	50.0	90	51	47.5	20.114	5	1.20	20.063	9042990200630
63	25	57	63.0	120	57	55.3	20.114	6	2.10	25.063	9042990250630
63	32	64	75.0	125	61	63	20.114	6	2.40	32.063	9042990320630
63	20	42	50.0	150	51	108	20.114	5	1.90	20.163	9042990201630
63	20	42	50.0	200	51	158	20.114	5	2.50	20.263	9042990202630
80	20	42	50.0	95	51	52	20.114	5	1.80	20.080	9042990200800
80	25	57	63.0	110	57	65	20.114	6	2.60	25.080	9042990250800
80	32	64	75.0	125	61	63	20.114	6	3.20	32.080	9042990320800
100	20	42	50.0	105	51	59	20.114	5	3.20	20.100	9042990201000
100	25	57	63.0	110	57	62	20.114	6	3.30	25.100	9042990251000
100	32	64	75.0	110	61	62	20.114	6	3.80	32.100	9042990321000
100	20	42	50.0	160	51	108	20.114	5	3.60	120.100	9042991201000
100	25	53	63.0	160	57	110	20.114	6	3.70	125.100	9042991251000
100	32	53	75.0	160	61	110	20.114	6	4.20	132.100	9042991321000
100	20	42	50.0	200	51	148	20.114	5	3.80	220.100	9042992201000
100	25	53	63.0	200	57	150	20.114	6	3.90	225.100	9042992251000
100	32	53	75.0	200	61	150	20.114	6	4.40	232.100	9042992321000

EXCLUSIVELINE®

CAT hydraulic chucks

Product information

- balancing quality: G6.3 / 15,000 rev./min
- taper according to ANSI/ASME B 5.50
- coolant through center and also through flange (plugged with set screws when supplied)
- axial length setting
- CAT 40 - 5/8 x 11 retention knob thread
- CAT 50 - 1" x 8 retention knob thread

Scope of delivery

- incl. setting screw, Guhring no. 4900
- incl. hex wrench, Guhring no. 4912
- special dimensions on request

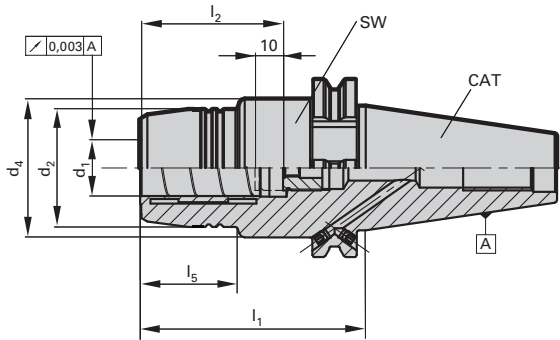

Series Number **4216**

CAT	for shank Ø d1 h6 mm	d2 mm	d4 mm	l1 mm	l2 mm	l5 mm	incl. setting screw 4900 ...	SW	kg	Code no.	EDP
40	20	42.0	44.5	64.0	51.0	34.0	20.114	5	1.12	20.040	9042160200400
40	25	49.5	44.5	81.0	57.0	40.0	20.114	6	1.34	25.040	9042160250400
40	32	63.0	80.0	81.0	61.0	25.5	20.114	6	1.90	32.040	9042160320400
50	20	42.0	69.9	81.0	51.0	34.0	20.114	5	3.42	20.050	9042160200500
50	25	57.0	69.9	81.0	57.0	40.0	20.114	6	3.62	25.050	9042160250500
50	32	63.0	69.9	81.0	61.0	45.0	20.114	6	3.61	32.050	9042160320500

EXCLUSIVE LINE®

CAT / HSK-C basic adaptors

Product information

- CAT taper to DIN 69871 form AD
- Form B on request
- Code no. 50,100 only applies to presetting unit
- for conventional cooling from 6 to max. 80 bar

Scope of delivery

- incl. clamping set, Guhring no. 4554
- incl. brass lock ring Guhring no. 4953
- order clamping key and pull studs separately

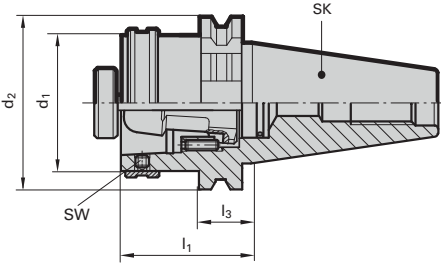

Series Number 4003

CAT taper	HSK-C d_1	d_2 mm	l_1 mm	SW	kg	Code no.	EDP
40	63	63.5	70	5.0	1.38	40.063	9040030400630
50	63	97.5	40	5.0	2.73	50.063	9040030500630

EXCLUSIVELINE®

GuhringNavigator

GÜHRING NAVIGATOR

HR 500 reamers up to 20.00 mm

Tools with **bold** feed column no. are preferred choice.

Counter-sink Ø mm	Feed column no.						
	71	72	73	74	75	76	77
	f (mm/rev.)						
< 4.00	0.080	0.100	0.125	0.300	0.500	0.800	1.000
4.00	0.100	0.125	0.160	0.300	0.500	1.000	1.200
5.00	0.100	0.125	0.160	0.400	0.600	1.000	1.400
6.30	0.125	0.160	0.200	0.400	0.700	1.200	1.600
8.00	0.160	0.200	0.250	0.600	1.000	1.800	2.400
10.00	0.200	0.250	0.315	0.600	1.200	1.800	2.400
12.50	0.200	0.250	0.315	0.800	1.200	2.000	2.500
16.00	0.250	0.315	0.400	0.800	1.400	2.200	2.600
20.00	0.315	0.400	0.500	0.800	1.400	2.200	2.600
25.00	0.400	0.500	0.630	1.000	1.600	2.500	3.000
31.50	0.400	0.500	0.630	1.000	2.000	3.000	3.600
40.00	0.500	0.630	0.800	1.200	2.000	3.000	3.600
50.00	0.630	0.800	1.000	1.400	2.200	3.200	3.600
> 50.00	0.800	1.000	1.250	1.600	2.200	3.200	3.600

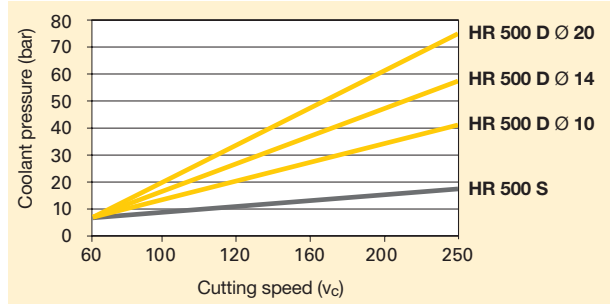

For an optimal cooling lubricant supply to HR 500 type D reamer cutting edges for through holes we recommend clamping in hydraulic or shrink fit chucks to the maximum clamping depth.

Material group	Material examples, new description (old description in brackets) Figures in bold = material no. to DIN EN	Tensile str. MPa (N/mm ²)	Hard- ness	Coolant
Common structural steels	1.0035 S185(St33), 1.0486 P275N(StE285), 1.0345 P235GH(H1), 1.0425 P265GH(H2)	≤500		●
	1.0050 E295 (St50-2), 1.0070 E360 (St70-2), 1.8937 P500NH (WStE500)	≤1000		●
Free-cutting steels	1.0718 11SMnPb30 (9SMnPb28), 1.0736 11SMn37 (9SMn36)	≤850		●
	1.0727 46S20 (45S20), 1.0728 (60S20), 1.0757 46SPb20 (45SPb20)	≤1000		●
Unalloyed heat-treatable steels	1.0402 C22, 1.1178 C30E (Ck30)	≤700		●
	1.0503 C45, 1.1191 C45E (Ck45)	≤850		●
	1.0601 C60, 1.1221 C60E (Ck60)	≤1000		●
Alloyed heat-treatable steels	1.5131 50MnSi4, 1.7003 38Cr2, 1.7030 28Cr4	≤1000		●
	1.5710 36NiCr6, 1.7035 41Cr4, 1.7225 42CrMo4	≤1400		●
Unalloyed case hard. steels	1.0301 (C10), 1.1121 C10E (Ck10)	≤850		●
Alloyed case hardened steels	1.7276 10CrMo11, 1.5125 11MnSi6	≤1000		●
	1.5752 15NiCr13, 1.7131 16MnCr5, 1.7264 20CrMo5	≤1400		●
Nitriding steels	1.8504 34CrAl6	≤1000		●
	1.8519 31CrMoV9, 1.8550 34CrAlNi7	≤1400		●
Tool steels	1.1750 C75W, 1.2067 102Cr6, 1.2307 29CrMoV9	≤850		●
	1.2080 X210Cr12, 1.2083 X42Cr13, 1.2419 105WCr6, 1.2767 X45NiCrMo4	≤1400		●
High speed steels	1.3243 S 6-5-2-5, 1.3343 S 6-5-2, 1.3344 S 6-5-3	≤1400		●
Spring steels	1.5026 55Si7, 1.7176 55Cr3, 1.8159 51CrV4 (51CrV4)		≤350 HB	●
Stainless steels, sulphured	1.4005 X12CrS13, 1.4104 X14CrMoS17, 1.4105 X6CrMoS17, 1.4305 X8CrNiS18-9	≤900		●
austenitic	1.4301 X5CrNi18-10 (V2A), 1.4541 X6CrNiTi18-10, 1.4571 X6CrNiMoTi 17-12-2 (V4A)	≤1100		●
martensitic	1.4057 X20CrNi172 (X17CrNi16-2), 1.4122 X39CrMo17-1, 1.4521 X2CrMoTi18-2	≤1500		●
Hardened steels	-		≤48 HRC ≤66 HRC	●
Special alloys	Nimonic, Inconel, Monel, Hastelloy	≤2000		●
Cast iron	0.6010 EN-GJL-100 (GG10), 0.6020 EN-GJL-200 (GG20)		≤240 HB ≤350 HB	●○
	0.6025 EN-GJL-250 (GG25), 0.6035 EN-GJL-350 (GG35)			●○
Spheroidal graphite iron and malleable cast iron	0.7040 EN-GJS-400-15 (GGG40), 0.7050 EN-GJS-500-7 (GGG50), 0.8035 EN-GJMW-350-4 (GTW35)		≤240 HB ≤350 HB	●○
Chilled cast iron	-		≤350 HB	●
Ti and Ti-alloys	3.7024 Ti99.5, 3.7114 TiAl5Sn2.5, 3.7124 TiCu2	≤850		●
	3.7154 TiAl6Zr5, 3.7165 TiAl6V4, 3.7184 TiAl4Mo4Sn2.5, - TiAl8Mo1V1	≤1400		●
Aluminum and Al-alloys	3.0255 Al99.5, 3.2315 AlMgSi1, 3.3515 AlMg1	≤400		●
Al wrought alloys	3.0615 AlMgSiPb, 3.1325 AlCuMg1, 3.3245 AlMg3Si, 3.4365 AlZnMgCu1.5	≤650		●
Al cast alloys ≤ 10 % Si	3.2131 G-AlSi5Cu1, 3.2153 G-AlSi7Cu3, 3.2573 G-AlSi9	≤600		●
≤ 24 % Si	3.2581 G-AlSi12, 3.2583 G-AlSi12Cu, - G-AlSi12CuNiMg	≤600		●
Magnesium alloys	3.5200 MgMn2, 3.5812.05 G-MgAl8Zn1, 3.5612.05 G-MgAl6Zn1	≤400		○
Copper, low-alloyed	2.0070 SE-Cu, 2.1020 CuSn6, 2.1096 G-CuSn5ZnPb	≤500		●
Brass, short-chipping	2.0380 CuZn39Pb2, 2.0401 CuZn39Pb3, 2.0410 CuZn43Pb2	≤600		●
long-chipping	2.0250 CuZn20, 2.0280 CuZn33, 2.0332 CuZn37Pb0.5	≤600		●
Bronze, short-chipping	2.1090 CuSn7ZnPb, 2.1170 CuPb5Sn5, 2.1176 CuPb10Sn	≤600		●
	2.0790 CuNi18Zn19Pb	≤850		●
Bronze, long-chipping	2.0916 CuAl5, 2.0960 CuAl9Mn, 2.1050 CuSn10	≤850		●
	2.0980 CuAl11Ni, 2.1247 CuBe2	≤1000		●
Duroplastics	Bakelit, Resopal, Pertinax, Moltopren	≤150		○
Thermoplastics	Plexiglass, Hostalen, Novodur, Makralon	≤100		○
New cast materials GGV	EN-GJV250 (GGV25), EN-GJV350 (GGV35)		≤220 HB	●○
	EN-GJV400 (GGV40), EN-GJV500 (GGV50), SiMo 6		≤300 HB	●○
New cast materials ADI	EN-GJS-800-8 (ADI800), EN-GJS-1000-5 (ADI1000)	≤1000		●○
	EN-GJS-1200-2 (ADI1200), EN-GJS-1400-1 (ADI1400)	≤1400		●○
Kevlar	Kevlar	≤1000		○
Glass, carbon conc. plastics	GFK/CFK	≤1000		○

Air ○
Neat oil ●
Soluble oil ●

EXCLUSIVE LINE®

Universal

GG/GGG

ALU

1685 / 1675	1686 / 1676
Solid carbide	Solid carbide
TiAlN nanoA	TiAlN nanoA
HR 500 S	HR 500 D

1036	1037
Solid carbide	Solid carbide
Signum	Signum
HR500 Guss S	HR500 Guss D

1678	1679
Solid carbide	Solid carbide
Carbo	Carbo
HR500 Alu S	HR500 Alu D



v_c m/min	Feed column no.	
120-250	75-76	75-76
120-250	75-76	75-76
120-250	75-76	75-76
120-250	75-76	75-76
120-250	75-76	75-76
120-250	75-76	75-76
120-250	75-76	75-76
120-250	75-76	75-76
120-250	75-76	75-76
120-250	75-76	75-76
120-250	75-76	75-76
120-250	75-76	75-76
120-250	75-76	75-76
120-250	75-76	75-76
120-250	75-76	75-76
60-120	75-76	75-76
30-60	73-74	73-74
60-120	74-75	74-75
40-80	74-75	74-75
60-120	74-75	74-75
40-60	73-74	73-74
30-60	73-74	73-74
40-60	74-75	74-75
60-140	75-76	75-76
60-140	75-76	75-76
120-250	74-75	74-75
60-120	74-75	74-75
30-50	74-75	74-75
40-60	74	74
40-60	74	74
80-160	75-76	75-76
100-250	75-76	75-76
100-250	75-76	75-76
100-250	75-76	75-76
80-200	75-76	75-76
80-200	75-76	75-76
80	75-76	75-76
80	75-76	75-76
80	71	71
80	71	71

v_c m/min	Feed column no.	
200	76	76
200	76	76
120-300	72-75	72-75
80-120	72-75	72-75
200	75-76	75-76
200	75-76	75-76

v_c m/min	Feed column no.	
200-300	76-77	76-77
200-300	76-77	76-77
200-300	76-77	76-77
200-300	76-77	76-77

EXCLUSIVELINE®

GuhringNavigator

GÜHRINGNAVIGATOR

HR 500 Reamers from Ø 20.00 mm up to 40.00 mm

Tools with **bold** feed column no. are preferred choice.

Counter-sink Ø mm	Feed column no.						
	71	72	73	74	75	76	77
	f (mm/rev.)						
< 4.00	0.080	0.100	0.125	0.300	0.500	0.800	1.000
4.00	0.100	0.125	0.160	0.300	0.500	1.000	1.200
5.00	0.100	0.125	0.160	0.400	0.600	1.000	1.400
6.30	0.125	0.160	0.200	0.400	0.700	1.200	1.600
8.00	0.160	0.200	0.250	0.600	1.000	1.800	2.400
10.00	0.200	0.250	0.315	0.600	1.200	1.800	2.400
12.50	0.200	0.250	0.315	0.800	1.200	2.000	2.500
16.00	0.250	0.315	0.400	0.800	1.400	2.200	2.600
20.00	0.315	0.400	0.500	0.800	1.400	2.200	2.600
25.00	0.400	0.500	0.630	1.000	1.600	2.500	3.000
31.50	0.400	0.500	0.630	1.000	2.000	3.000	3.600
40.00	0.500	0.630	0.800	1.200	2.000	3.000	3.600
50.00	0.630	0.800	1.000	1.400	2.200	3.200	3.600
> 50.00	0.800	1.000	1.250	1.600	2.200	3.200	3.600

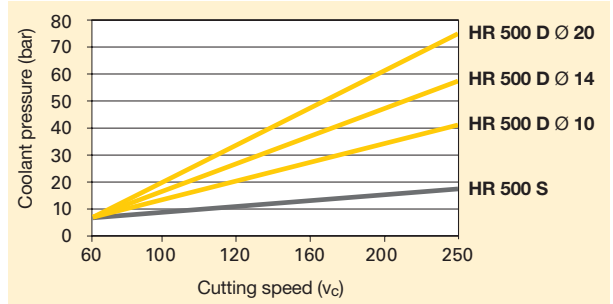

For an optimal cooling lubricant supply to HR 500 type D reamer cutting edges for through holes we recommend clamping in hydraulic or shrink fit chucks to the maximum clamping depth.

Material group	Material examples, new description (old description in brackets) Figures in bold = material no. to DIN EN	Tensile str. MPa (N/mm ²)	Hard- ness	Coolant
Common structural steels	1.0035 S185(St33), 1.0486 P275N(StE285), 1.0345 P235GH(H1), 1.0425 P265GH(H2)	≤500		●
	1.0050 E295 (St50-2), 1.0070 E360 (St70-2), 1.8937 P500NH (WStE500)	≤1000		●
Free-cutting steels	1.0718 11SMnPb30 (9SMnPb28), 1.0736 11SMn37 (9SMn36)	≤850		●
	1.0727 46S20 (45S20), 1.0728 (60S20), 1.0757 46SPb20 (45SPb20)	≤1000		●
Unalloyed heat-treatable steels	1.0402 C22, 1.1178 C30E (Ck30)	≤700		●
	1.0503 C45, 1.1191 C45E (Ck45)	≤850		●
	1.0601 C60, 1.1221 C60E (Ck60)	≤1000		●
Alloyed heat-treatable steels	1.5131 50MnSi4, 1.7003 38Cr2, 1.7030 28Cr4	≤1000		●
	1.5710 36NiCr6, 1.7035 41Cr4, 1.7225 42CrMo4	≤1400		●
Unalloyed case hard. steels	1.0301 (C10), 1.1121 C10E (Ck10)	≤850		●
Alloyed case hardened steels	1.7276 10CrMo11, 1.5125 11MnSi6	≤1000		●
	1.5752 15NiCr13, 1.7131 16MnCr5, 1.7264 20CrMo5	≤1400		●
Nitriding steels	1.8504 34CrAl6	≤1000		●
	1.8519 31CrMoV9, 1.8550 34CrAlNi7	≤1400		●
Tool steels	1.1750 C75W, 1.2067 102Cr6, 1.2307 29CrMoV9	≤850		●
	1.2080 X210Cr12, 1.2083 X42Cr13, 1.2419 105WCr6, 1.2767 X45NiCrMo4	≤1400		●
High speed steels	1.3243 S 6-5-2-5, 1.3343 S 6-5-2, 1.3344 S 6-5-3	≤1400		●
Spring steels	1.5026 55Si7, 1.7176 55Cr3, 1.8159 51CrV4 (51CrV4)		≤350 HB	●
Stainless steels, sulphured	1.4005 X12CrS13, 1.4104 X14CrMoS17, 1.4105 X6CrMoS17, 1.4305 X8CrNiS18-9	≤900		●
austenitic	1.4301 X5CrNi18-10 (V2A), 1.4541 X6CrNiTi18-10, 1.4571 X6CrNiMoTi 17-12-2 (V4A)	≤1100		●
martensitic	1.4057 X20CrNi172 (X17CrNi16-2), 1.4122 X39CrMo17-1, 1.4521 X2CrMoTi18-2	≤1500		●
Hardened steels	-		≤48 HRC ≤66 HRC	●
Special alloys	Nimonic, Inconel, Monel, Hastelloy	≤2000		●
Cast iron	0.6010 EN-GJL-100 (GG10), 0.6020 EN-GJL-200 (GG20)		≤240 HB	●
	0.6025 EN-GJL-250 (GG25), 0.6035 EN-GJL-350 (GG35)		≤350 HB	●
Spheroidal graphite iron and malleable cast iron	0.7040 EN-GJS-400-15 (GGG40), 0.7050 EN-GJS-500-7 (GGG50), 0.8035 EN-GJMW-350-4 (GTW35)		≤240 HB	●
	0.7070 EN-GJS-700-2 (GGG70), 0.8170 EN-GJMB-700-2 (GTS70)		≤350 HB	●
Chilled cast iron	-		≤350 HB	●
Ti and Ti-alloys	3.7024 Ti99.5, 3.7114 TiAl5Sn2.5, 3.7124 TiCu2	≤850		●
	3.7154 TiAl6Zr5, 3.7165 TiAl6V4, 3.7184 TiAl4Mo4Sn2.5, - TiAl8Mo1V1	≤1400		●
Aluminum and Al-alloys	3.0255 Al99.5, 3.2315 AlMgSi1, 3.3515 AlMg1	≤400		●
Al wrought alloys	3.0615 AlMgSiPb, 3.1325 AlCuMg1, 3.3245 AlMg3Si, 3.4365 AlZnMgCu1.5	≤650		●
Al cast alloys ≤ 10 % Si	3.2131 G-AlSi5Cu1, 3.2153 G-AlSi7Cu3, 3.2573 G-AlSi9	≤600		●
≤ 24 % Si	3.2581 G-AlSi12, 3.2583 G-AlSi12Cu, - G-AlSi12CuNiMg	≤600		●
Magnesium alloys	3.5200 MgMn2, 3.5812.05 G-MgAl8Zn1, 3.5612.05 G-MgAl6Zn1	≤400		○
Copper, low-alloyed	2.0070 SE-Cu, 2.1020 CuSn6, 2.1096 G-CuSn5ZnPb	≤500		●
Brass, short-chipping	2.0380 CuZn39Pb2, 2.0401 CuZn39Pb3, 2.0410 CuZn43Pb2	≤600		●
long-chipping	2.0250 CuZn20, 2.0280 CuZn33, 2.0332 CuZn37Pb0.5	≤600		●
Bronze, short-chipping	2.1090 CuSn7ZnPb, 2.1170 CuPb5Sn5, 2.1176 CuPb10Sn	≤600		●
	2.0790 CuNi18Zn19Pb	≤850		●
Bronze, long-chipping	2.0916 CuAl5, 2.0960 CuAl9Mn, 2.1050 CuSn10	≤850		●
	2.0980 CuAl11Ni, 2.1247 CuBe2	≤1000		●
Duroplastics	Bakelit, Resopal, Pertinax, Moltopren	≤150		○
Thermoplastics	Plexiglass, Hostalen, Novodur, Makralon	≤100		○
New cast materials GGV	EN-GJV250 (GGV25), EN-GJV350 (GGV35)		≤220 HB	○
	EN-GJV400 (GGV40), EN-GJV500 (GGV50), SiMo 6		≤300 HB	○
New cast materials ADI	EN-GJS-800-8 (ADI800), EN-GJS-1000-5 (ADI1000)	≤1000		○
	EN-GJS-1200-2 (ADI1200), EN-GJS-1400-1 (ADI1400)	≤1400		○
Kevlar	Kevlar	≤1000		○
Glass, carbon conc. plastics	GFK/CFK	≤1000		○

Air ○
Neat oil ●
Soluble oil ●

EXCLUSIVE LINE®

HR 500 G high-performance reamers

1680	1681
Solid carbide	
TiAlN nanoA	
HR 500 G S	HR 500 G D



1682	1683
Cermet tipped	
bright	
HR 500 G S	HR 500 G D



V _c m/min	Feed column no.	
25-40	74-75	74-75
25-40	74-75	74-75
25-40	74-75	74-75
25-40	74-75	74-75
25-40	74-75	74-75
25-40	74-75	74-75
25-40	74-75	74-75
25-40	74	74
25-40	74-75	74-75
25-40	74-75	74-75
25-40	74	74
25-40	74-75	74-75
25-40	74	74
25-40	74-75	74-75
25-40	74-75	74-75
20-30	74	74
20-30	74-75	74-75
30-60	74-75	74-75
20-30	74-75	74-75
20-30	74-75	74-75
10-20	72-73	72-73
20-30	73-74	73-74
40-100	75-76	75-76
40-100	75-76	75-76
50-120	75-76	75-76
50-100	75-76	75-76
20-40	74-75	74-75
20-40	73-74	73-74
20-40	73-74	73-74
80-160	75-76	75-76
40-120	74-75	74-75
50-120	74-75	74-75
50-120	74-75	74-75
40-120	74-75	74-75
40-120	74-75	74-75
60-80	74-75	74-75
40-80	74-75	74-75
80	71	71
80	71	71

V _c m/min	Feed column no.	
100-180	75-76	75-76
100-180	75-76	75-76
100-180	75-76	75-76
100-180	75-76	75-76
100-180	75-76	75-76
100-180	75-76	75-76
100-180	75-76	75-76
100-180	75-76	75-76
100-180	75-76	75-76
80-120	75-76	75-76
100-180	75-76	75-76
100-180	75-76	75-76
100-180	75-76	75-76
80-120	75-76	75-76
100-180	75-76	75-76
80-120	75-76	75-76
100-180	75-76	75-76
80-120	75-76	75-76
100-120	74-75	74-75
120-300	72-75	72-75

EXCLUSIVELINE®

GuhringNavigator

GÜHRINGNAVIGATOR

HR 500 Reamers from Ø 41.00 mm up to 76.00 mm

Tools with **bold** feed column no. are preferred choice.

Guhring no.
Tool material
Surface finish
Type

Counter-sink Ø mm	Feed column no.						
	71	72	73	74	75	76	77
	f (mm/rev.)						
< 4.00	0.080	0.100	0.125	0.300	0.500	0.800	1.000
4.00	0.100	0.125	0.160	0.300	0.500	1.000	1.200
5.00	0.100	0.125	0.160	0.400	0.600	1.000	1.400
6.30	0.125	0.160	0.200	0.400	0.700	1.200	1.600
8.00	0.160	0.200	0.250	0.600	1.000	1.800	2.400
10.00	0.200	0.250	0.315	0.600	1.200	1.800	2.400
12.50	0.200	0.250	0.315	0.800	1.200	2.000	2.500
16.00	0.250	0.315	0.400	0.800	1.400	2.200	2.600
20.00	0.315	0.400	0.500	0.800	1.400	2.200	2.600
25.00	0.400	0.500	0.630	1.000	1.600	2.500	3.000
31.50	0.400	0.500	0.630	1.000	2.000	3.000	3.600
40.00	0.500	0.630	0.800	1.200	2.000	3.000	3.600
50.00	0.630	0.800	1.000	1.400	2.200	3.200	3.600
> 50.00	0.800	1.000	1.250	1.600	2.200	3.200	3.600

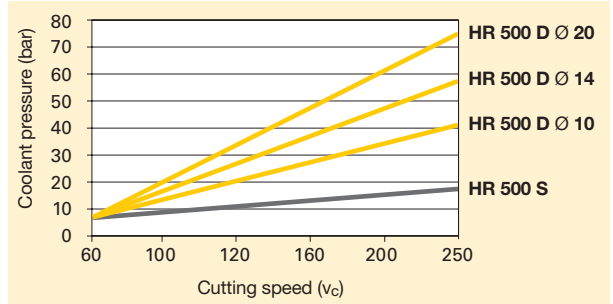

For an optimal cooling lubricant supply to HR 500 type D reamer cutting edges for through holes we recommend clamping in hydraulic or shrink fit chucks to the maximum clamping depth.

Material group	Material examples, new description (old description in brackets) Figures in bold = material no. to DIN EN	Tensile str. MPa (N/mm²)	Hard- ness	Coolant
Common structural steels	1.0035 S185(St33), 1.0486 P275N(StE285), 1.0345 P235GH(H1), 1.0425 P265GH(H2)	≤500		●
	1.0050 E295 (St50-2), 1.0070 E360 (St70-2), 1.8937 P500NH (WStE500)	≤1000		●
Free-cutting steels	1.0718 11SMnPb30 (9SMnPb28), 1.0736 11SMn37 (9SMn36)	≤850		●
	1.0727 46S20 (45S20), 1.0728 (60S20), 1.0757 46SPb20 (45SPb20)	≤1000		●
Unalloyed heat-treatable steels	1.0402 C22, 1.1178 C30E (Ck30)	≤700		●
	1.0503 C45, 1.1191 C45E (Ck45)	≤850		●
	1.0601 C60, 1.1221 C60E (Ck60)	≤1000		●
Alloyed heat-treatable steels	1.5131 50MnSi4, 1.7003 38Cr2, 1.7030 28Cr4	≤1000		●
	1.5710 36NiCr6, 1.7035 41Cr4, 1.7225 42CrMo4	≤1400		●
Unalloyed case hard. steels	1.0301 (C10), 1.1121 C10E (Ck10)	≤850		●
Alloyed case hardened steels	1.7276 10CrMo11, 1.5125 11MnSi6	≤1000		●
	1.5752 15NiCr13, 1.7131 16MnCr5, 1.7264 20CrMo5	≤1400		●
Nitriding steels	1.8504 34CrAl6	≤1000		●
	1.8519 31CrMoV9, 1.8550 34CrAlNi7	≤1400		●
Tool steels	1.1750 C75W, 1.2067 102Cr6, 1.2307 29CrMoV9	≤850		●
	1.2080 X210Cr12, 1.2083 X42Cr13, 1.2419 105WCr6, 1.2767 X45NiCrMo4	≤1400		●
High speed steels	1.3243 S 6-5-2-5, 1.3343 S 6-5-2, 1.3344 S 6-5-3	≤1400		●
Spring steels	1.5026 55Si7, 1.7176 55Cr3, 1.8159 51CrV4 (51CrV4)		≤350 HB	●
Stainless steels, sulphured	1.4005 X12CrS13, 1.4104 X14CrMoS17, 1.4105 X6CrMoS17, 1.4305 X8CrNiS18-9	≤900		●
austenitic	1.4301 X5CrNi18-10 (V2A), 1.4541 X6CrNiTi18-10, 1.4571 X6CrNiMoTi 17-12-2 (V4A)	≤1100		●
martensitic	1.4057 X20CrNi172 (X17CrNi16-2), 1.4122 X39CrMo17-1, 1.4521 X2CrMoTi18-2	≤1500		●
Hardened steels	-		≤48 HRC ≤66 HRC	●
Special alloys	Nimonic, Inconel, Monel, Hastelloy	≤2000		●
Cast iron	0.6010 EN-GJL-100 (GG10), 0.6020 EN-GJL-200 (GG20)		≤240 HB ≤350 HB	●○
	0.6025 EN-GJL-250 (GG25), 0.6035 EN-GJL-350 (GG35)			●○
Spheroidal graphite iron and malleable cast iron	0.7040 EN-GJS-400-15 (GGG40), 0.7050 EN-GJS-500-7 (GGG50), 0.8035 EN-GJMW-350-4 (GTW35)		≤240 HB ≤350 HB	●○
	0.7070 EN-GJS-700-2 (GGG70), 0.8170 EN-GJMB-700-2 (GTS70)			●○
Chilled cast iron	-		≤350 HB	●
Ti and Ti-alloys	3.7024 Ti99.5, 3.7114 TiAl5Sn2.5, 3.7124 TiCu2	≤850		●
	3.7154 TiAl6Zr5, 3.7165 TiAl6V4, 3.7184 TiAl4Mo4Sn2.5, - TiAl8Mo1V1	≤1400		●
Aluminum and Al-alloys	3.0255 Al99.5, 3.2315 AlMgSi1, 3.3515 AlMg1	≤400		●
Al wrought alloys	3.0615 AlMgSiPb, 3.1325 AlCuMg1, 3.3245 AlMg3Si, 3.4365 AlZnMgCu1.5	≤650		●
Al cast alloys ≤ 10 % Si	3.2131 G-AlSi5Cu1, 3.2153 G-AlSi7Cu3, 3.2573 G-AlSi9	≤600		●
≤ 24 % Si	3.2581 G-AlSi12, 3.2583 G-AlSi12Cu, - G-AlSi12CuNiMg	≤600		●
Magnesium alloys	3.5200 MgMn2, 3.5812.05 G-MgAl8Zn1, 3.5612.05 G-MgAl6Zn1	≤400		○
Copper, low-alloyed	2.0070 SE-Cu, 2.1020 CuSn6, 2.1096 G-CuSn5ZnPb	≤500		○
Brass, short-chipping	2.0380 CuZn39Pb2, 2.0401 CuZn39Pb3, 2.0410 CuZn43Pb2	≤600		○
long-chipping	2.0250 CuZn20, 2.0280 CuZn33, 2.0332 CuZn37Pb0.5	≤600		○
Bronze, short-chipping	2.1090 CuSn7ZnPb, 2.1170 CuPb5Sn5, 2.1176 CuPb10Sn	≤600		○●
	2.0790 CuNi18Zn19Pb	≤850		●
Bronze, long-chipping	2.0916 CuAl5, 2.0960 CuAl9Mn, 2.1050 CuSn10	≤850		●
	2.0980 CuAl11Ni, 2.1247 CuBe2	≤1000		●
Duroplastics	Bakelit, Resopal, Pertinax, Moltopren	≤150		○
Thermoplastics	Plexiglass, Hostalen, Novodur, Makralon	≤100		○
New cast materials GGV	EN-GJV250 (GGV25), EN-GJV350 (GGV35)		≤220 HB	○
	EN-GJV400 (GGV40), EN-GJV500 (GGV50), SiMo 6		≤300 HB	○
New cast materials ADI	EN-GJS-800-8 (ADI800), EN-GJS-1000-5 (ADI1000)	≤1000		○
	EN-GJS-1200-2 (ADI1200), EN-GJS-1400-1 (ADI1400)	≤1400		○
Kevlar	Kevlar	≤1000		○
Glass, carbon conc. plastics	GFK/CFK	≤1000		○

Air ○
Neat oil ●
Soluble oil ●

EXCLUSIVE^{LINE}[®]

HR 500 GT high-performance reamers

1038	1039
Solid carbide	Solid carbide
TiAlN nanoA	TiAlN nanoA
HR 500 GT S	HR 500 GT D

1040	1041
Cermet	Cermet
bright	bright
HR 500 GT S	HR 500 GT D



V _c m/min	Feed column no.	
25-40	74-75	74-75
25-40	74-75	74-75
25-40	74-75	74-75
25-40	74-75	74-75
25-40	74-75	74-75
25-40	74-75	74-75
25-40	74-75	74-75
25-40	74	74
25-40	74-75	74-75
25-40	74-75	74-75
25-40	74	74
25-40	74-75	74-75
25-40	74	74
25-40	74-75	74-75
25-40	74	74
20-30	74	74
20-30	74-75	74-75
30-60	74-75	74-75
20-30	74-75	74-75
20-30	74-75	74-75
10-20	72-73	72-73
20-30	73-74	73-74
40-100	75-76	75-76
40-100	75-76	75-76
50-120	75-76	75-76
50-100	75-76	75-76
20-40	74-75	74-75
20-40	73-74	73-74
20-40	73-74	73-74
80-160	75-76	75-76
40-120	74-75	74-75
50-120	74-75	74-75
50-120	74-75	74-75
40-120	74-75	74-75
40-120	74-75	74-75
60-80	74-75	74-75
40-80	74-75	74-75
40-120	71	71
40-120	71	71

V _c m/min	Feed column no.	
100-180	75-76	75-76
100-180	75-76	75-76
100-180	75-76	75-76
100-180	75-76	75-76
100-180	75-76	75-76
100-180	75-76	75-76
100-180	75-76	75-76
100-180	75-76	75-76
100-180	75-76	75-76
100-180	75-76	75-76
80-120	74	74
100-180	75-76	75-76
100-180	75-76	75-76
80-120	74	74
100-180	75-76	75-76
80-120	74	74
100-180	75-76	75-76
80-120	74	74
100-120	74-75	74-75
120-300	72-75	72-75

EXCLUSIVE^{LINE}[®]

Application examples

Application examples for Guhring's HR 500 S and HR 500 D solid carbide high-performance reamers with highest feed rates and tool life.

The HR 500 S and HR 500 D solid carbide high-performance reamers have shown their performance in several applications, see following table:

Tool type	HR 500 S	HR 500 D	HR 500 D	HR 500 S	HR 500 Cast D
Guhring no.	1685	1686	special reamer for tighter tolerances	1685	1037
component machined	hinge	ring	valve body	ring	cylinder head
workpiece material	gen. steel	alloyed steel	gen. steel	alloyed steel	GG 30
hole diameter (mm)	9	8	5,9	15	20.2
hole tolerance	H7	H7	H6	IT 5	H7
reaming depth (mm)	30	25	48	20	60
cutting speed v_c (m/min.)	120	200	190	250	200
feed rate v_f (mm/min.)	4200	12700	6100	7200	6300
tool life (m)	60	100	55	200	150

Application examples for Guhring special high-performance reamers HR 500 G

Carbide- or cermet-tipped special high-performance reamers HR 500 G S and HR 500 G D have already been able to demonstrate their efficiency in numerous applications. The following table contains some examples.

Tool type	HR 500 G D	HR 500 G D	HR 500 G D
Guhring no.	1683 (shortened)	1681	1683
tool material/coating	Cermet	HM + TiAlN nanoA	Cermet
component machined	universal joint	wheel flange	differential housing
workpiece material	steel	cast iron	cast iron
hole diameter (mm)	25	22	32
hole tolerance	F7	H8	H7
reaming depth (mm)	18	20	50
cutting speed v_c (m/min.)	130	120	120
feed rate v_f (mm/min.)	2000	2600	3000
tool life (m)	175	120	160

EXCLUSIVE^{LINE}[®]

HR 500 ACTIVE

Special range of HR 500 solid carbide high-performance reamers



Ever since their introduction, Guhring's solid carbide high-performance reamers HR 500 D for through holes and HR 500 S for blind holes have impressed customers with their outstanding performance. Even under difficult machining conditions such as interrupted cutting or unstable machines they ream holes at cutting rates higher than cermet levels with maximum tool life and optimal quality in almost all materials.

So the user can also fully utilise the advantages of HR 500 high-performance reamers for the machining of the special applications Guhring has developed the HR 500 ACTIVE range.

There is a choice of four HR 500 ACTIVE types:

- for cylindrical blind holes
- for cylindrical through holes
- for stepped blind holes
- for stepped through holes

The four HR 500 ACTIVE types are available in the following designs:

- with or without internal cooling
- short or long version
- with different coatings or bright finish
- to hole tolerance or reamer manufacturing tolerance

You have the choice of designing the optimal HR 500 reamer for your specific application! Simply complete the questionnaire.

EXCLUSIVELINE®

HR 500 ACTIVE Solid carbide reamers in special dimensions

www.guhring.com

Order

Name/customer no. if available

New customer

Street no.

Telephone

Date

Inquiry

Contact for questions

Order no.

Town/post code

Fax

Signature

Quantity

Minimum order quantity 5 tools

Hole Ø / tol.

or

Reamers manufact. Ø / tol.

Nom.-Ø d ₁	Tolerance	Example	Example
<input type="text"/>	<input type="text"/>	Ø 2 F8	Ø 2 ^{+0,03} _{+0,01}
Nom.-Ø d ₁	upper/lower limit	Example	
<input type="text"/>	<input type="text"/>	Ø 2 ^{+0,008} _{+0,002}	

Blind hole

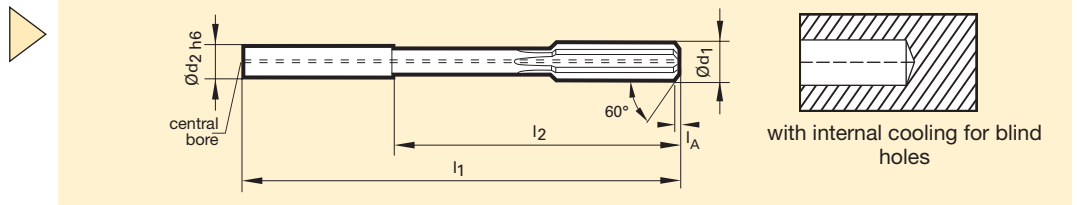

Through hole

with internal cooling

without internal cooling

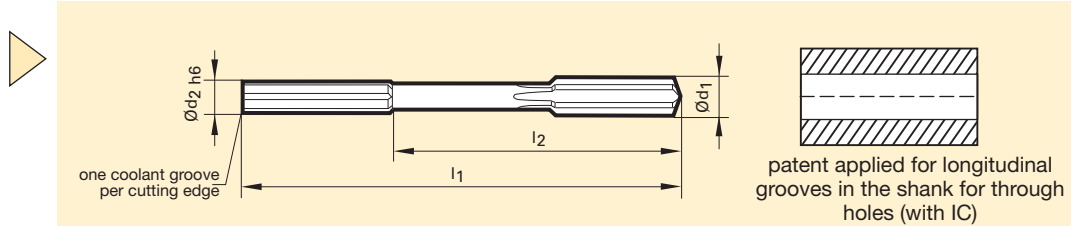

Dimensions

long version

short version

Further dimensions on request

Nom.-Ø [mm] from - to d ₁	long version		short version		Chamfer length l _A (only blind holes)	Shank-Ø h6 DIN 6535 d ₂
	l ₁	Reach l ₂	l ₁	Reach l ₂		
2.950 - 4.1	68	40	-	-	0.4	4
4.101 - 6.1	76	40	-	-	0.4	6
6.101 - 8.1	101	65	76	40	0.4	8
8.101 - 10.1	101	61	76	36	0.4	10
10.101 - 12.1	130	85	80	35	0.5	12
12.101 - 14.1	130	85	90	45	0.5	14
14.101 - 16.1	150	102	90	42	0.5	16
16.101 - 18.1	150	102	100	52	0.5	18
18.101 - 20.1	150	100	100	50	0.5	20

Coating

TiAlN (optimal for the machining of steel and universal application)

Zenit (optimal for the machining of titanium)

Signum (optimal for the machining of GG/GGG)

Carbo (optimal for the machining of Al)

Material

steel/hardened steel/
special alloys/VA

GG/ GGG
HR 500 CAST: Delivery time appr. 4 weeks

Al-wrought-cast alloys
Delivery time appr. 5 weeks

EXCLUSIVELINE®

HR 500 ACTIVE Solid carbide step reamers made to measure

www.guhring.com

Order **Inquiry**

Name/customer no. if available New customer

Street no.

Telephone

Date

Contact for questions

Order no.

Town/post code

Fax

Signature

Quantity Minimum order quantity 5 tools

Hole Ø / tol. or **Reamers manufact. Ø / tol.**

 Example Example

nom.-Ø d₁ upper/lower limit step-Ø d₃ upper/lower limit Example Example

cyl. step length/ countersink angle

Step length l₃ ±0.1

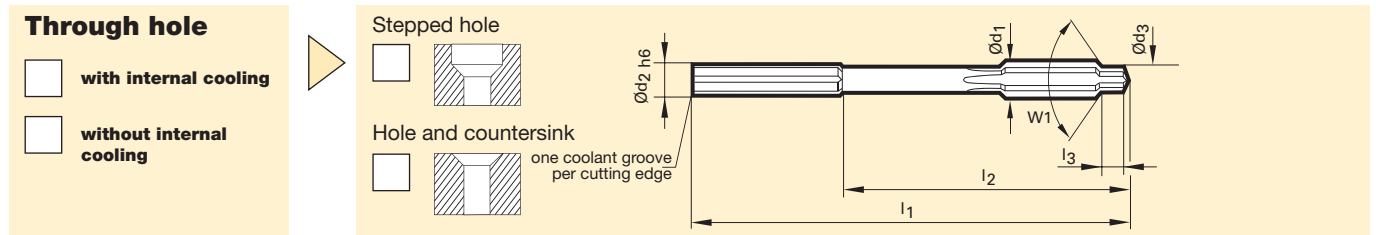
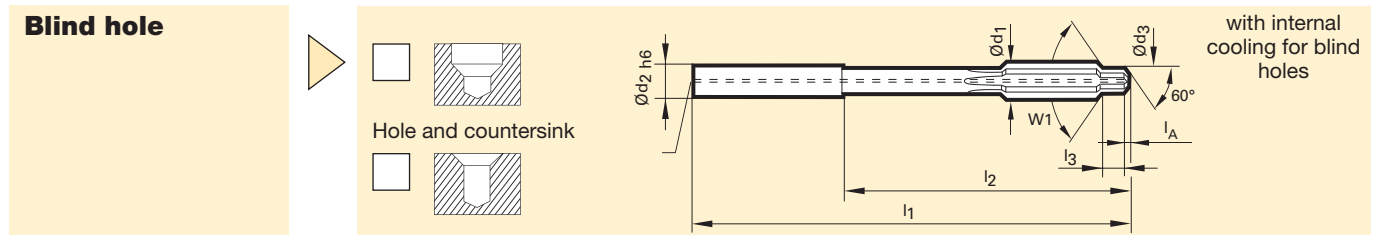

Dimensions

long version
 short version

Further dimensions on request

Nom.-Ø [mm] from - to d ₁	smallest poss. step-Ø d ₃	long version		short version		Chamfer length l _A (only blind holes)	Shank-Ø h ₆ DIN 6535 d ₂
		l ₁	Reach l ₂	l ₁	Reach l ₂		
2.950 - 4.1	d1x0.7 (min.Ø2.95)	68	40	-	-	0.4	4
4.101 - 6.1	d1x0.7 (min.Ø2.95)	76	40	-	-	0.4	6
6.101 - 8.1	d1 x 0.8	101	65	76	40	0.4	8
8.101 - 10.1	d1 x 0.8	101	61	76	36	0.4	10
10.101 - 12.1	d1 x 0.8	130	85	80	35	0.5	12
12.101 - 14.1	d1 x 0.8	130	85	90	45	0.5	14
14.101 - 16.1	d1 x 0.8	150	102	90	42	0.5	16
16.101 - 18.1	d1 x 0.8	150	102	100	52	0.5	18
18.101 - 20.1	d1 x 0.8	150	100	100	50	0.5	20

Coating

TiAlN (optimal for the machining of steel and universal application) Zenit (optimal for the machining of titanium) Signum (optimal for the machining of GG/GGG) Carbo (optimal for the machining of Al)

Material

steel/hardened steel/ special alloys/VA GG/ GGG HR 500 CAST: Delivery time appr. 4 weeks Al-wrought-cast alloys Delivery time appr. 5 weeks

EXCLUSIVE LINE®

HR 500 G / GT

www.guhring.com

Order **Inquiry**

New customer
Name/customer no. if available

Street no.

Telephone

Date

Contact for questions

Order no.

Town/post code

Fax

Signature

Hole Ø / tol.

or

**Reamers
manufact. Ø / tol.**



nom.-Ø d₁ upper/lower limit

Example 1

Ø 2 F8

Example 2

Ø 2 +0,02
 -0,004



nom.-Ø d₁ upper/lower limit

Example

Ø 2 +0,01
 -0,004

Machining

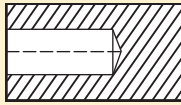

Blind hole

Depth: _____

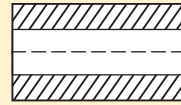

Through hole

Depth: _____

Coolant supply



Internal coolant Pressure: _____

External coolant

MQL

Material



Material Nr.: _____

**Required Surface
Quality**



Ra, Rz: _____

Notes/drawings

--	--

Guhring, Inc. Main Office
P.O. Box 643, Brookfield, WI 53008-0643

Shipping Address
1445 Commerce Avenue
Brookfield, WI 53045
Tel (262) 784-6730 (800) 776-6170
Fax (262) 784-9096

**West Coast Distribution Center and
Reconditioning Facility**
15581 Computer Ln
Huntington Beach, CA 92649

Reconditioning Facility
121 W Dudley Town Rd.
Bloomfield, CT 06002

**Manufacturing and
Reconditioning Facility**
29550 W.K. Smith Rd. Suite B
New Hudson, MI 48165

Guhring Corporation
20 Steckle Place, Unit #14
Kitchener, ON N2E 2C3
Tel (519) 748-9664 (800) 463-5555
Fax (519) 748-2954

EXCLUSIVELINE®